

功率器件产品手册

翠展微电子

2021



公司介绍

翠展微电子成立于2018年5月，公司位于中国上海张江综合性国家科学中心的张江集成电路产业区内，工厂位于浙江省嘉善县经济技术开发区。

作为一家中国本土的汽车级功率器件与模拟集成电路设计销售公司，公司立志打破进口垄断，实现进口替代，将翠展微电子打造成为新能源汽车半导体行业的中国品牌领军企业。公司将聚焦中国新能源汽车行业的挑战和压力，提供有竞争力的半导体产品和服务，持续为新能源汽车客户创造价值。

公司团队由多名业内资深人员构成，成员具有平均15年国际汽车半导体公司及汽车电子行业的销售、应用、方案设计与设计研发经验，在汽车级功率器件与集成电路产品领域具有雄厚的研发实力和销售渠道。我们有一支专业、坚韧、有活力的人才队伍，坚持以技术为导向，为客户提供个性化、系统级的产品与技术咨询服务，致力于提供优良的技术服务和高性价比的产品，驱动中国汽车电子产业快速蓬勃发展，共筑中国芯，中国梦！



IGBT 模块产品

IGBT Module

型号/ 功能描述	V _{CEs}	I _c	电路结构	封装形式	应用	状态
GCV300F65H1J11RRY	650V	300A	三相全桥	HP-1	汽车	量产
GCV400F65H1J11IRY	650V	400A	三相全桥	HP-1	汽车	量产
GCV400F65DCJ18IRY	650V	400A	三相全桥	DC6	汽车	量产
GCV450B65EJ29	650V	450A	半桥	Econodual	汽车	量产
GCV400F75H1O11Y	750V	400A	三相全桥	HP1	汽车	样品
GCV550F75H1J11IY	750V	550A	三相全桥	HP1	汽车	量产
GCV550F75DCJ11IY	750V	550A	三相全桥	DC6	汽车	量产
GCV820F75HDJ14IY	750V	820A	三相全桥	HPD	汽车	量产
GCV300B120EJ11IY	1200V	300A	半桥	Econodual	汽车/工业	样品
GCV450B120EJ11IY	1200V	450A	半桥	Econodual	汽车/工业	样品

IGBT 模块产品性能对比

Grecon IGBT Module vs Competitor

动态测试性能对比

测试条件: V_{CC}=410V, V_{GE}= -2V~+15V, R_{gon}=3.3Ω, R_{goff}=9Ω, T_j=25°C, L_s=25nH, L_d=36nH, 低电感平台

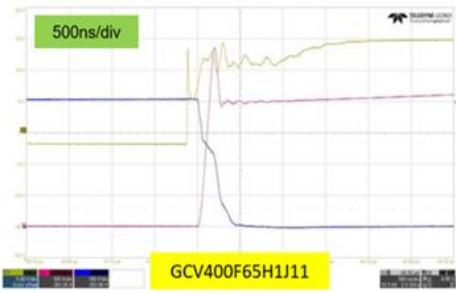
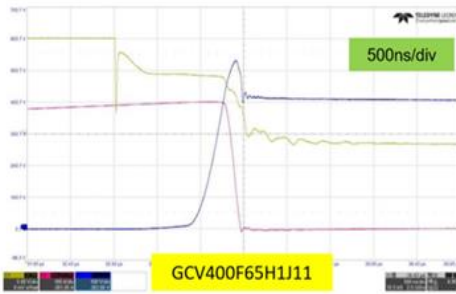
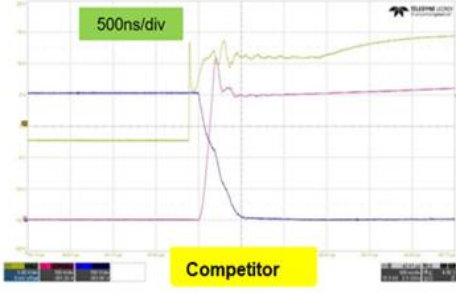
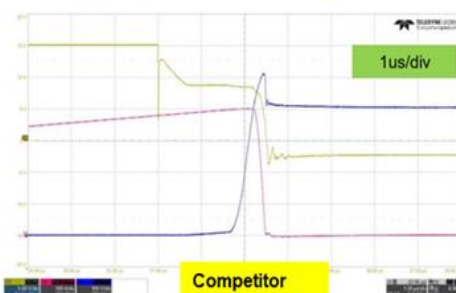
	GCV400F65H1J11	Competitor	Turn-on	Turn-off
t _{don} (ns)	158	152.8		
t _r (ns)	94	108.8		
t _{doff} (ns)	1297.6	2284.0		
t _f (ns)	131.2	178.8		
E _{on} (mJ)	22.73	24.9		
E _{off} (mJ)	46.93	67.24		

沟槽删 MOSFET < 250V

Trench MOSFET

极性	VDS (V)	Ron@10Vgs(mΩ)		Package	极性	VDS (V)	Ron@10Vgs(mΩ)		Package
		Typ	Max				Typ	Max	
N	40	3.6	4.3	TO252/ TO263/ TO220/ TO247	N	100	42	TO252/ TO263/ TO220/ TO247	
N	40	4	5		N	100	80		130
N	40	4.5	5.5		N	100	110		150
N	40	8	11		N	100	130		150
N	40	11	15		N	150	4.5		6
N	40	19	24		N	150	10		10
N	40	25	30		N	200	23		25
N	45	9.5	11.5		N	230	13		15.5
N	45	14.5	18.5		P	-40	10		15
N	60	8.4	10.2		P	-40	15		21
N	60	14	17		P	-40	30		35
N	60	26	33		P	-60	33		40
N	70	3.5							

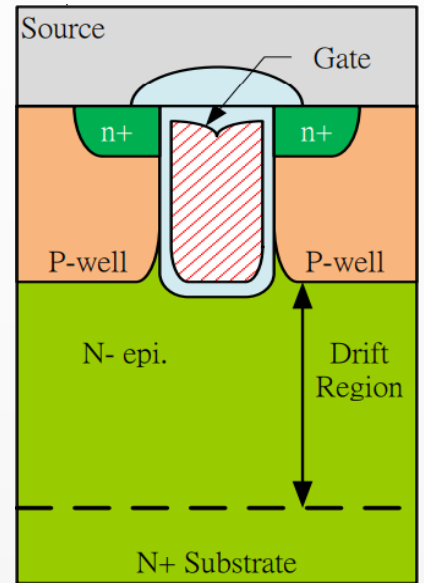

Normal RDSON
Normal SW Speed
Normal SOA/EAS

分裂删型沟槽 MOSFET < 250V

Split Gate Trench MOSFET

极性	VDS (V)	Ron@10Vgs(mΩ)		Package	极性	VDS (V)	Ron@10Vgs(mΩ)		Package
		Typ	Max				Typ	Max	
N	60	2.5	3.3	TO252/ TO263/ TO220/ TO247	N	100	3.6	4.7	TO252/ TO263/ TO220/ TO247
N	60	4	5.5		N	100	4	5.2	
N	60	8	10		N	100	6.5	8.5	
N	60	8.8	12		N	100	8	10.5	
N	80	2.9	3.6		N	100	12	15	
N	80	3	3.6		N	150	17	21	
N	100	2.5	5.0		N	150	43	50	
N	100	3.4	4.5		N	150	55	70	
N	100	3.5	4.6		N	150	68	80	

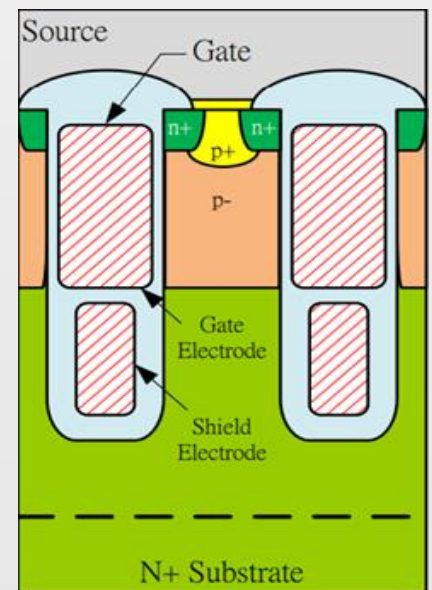

Smallest RDSON
Fast SW Speed
Week SOA/EAS

IGBT 模块定制产品，集成散热水道的 IGBT 模块

---工程样品

翠展集成散热水道 IGBT 模块的优点：

1. 不需要铜底板，减小热阻
2. 不需要导热硅脂，减小热阻，提高系统寿命和可靠性，并减少了生产工序。
3. 电机控制器壳体上不需要加工散热水道，结构更加简单，更易加工和装配。

常规 IGBT 模块常规 IGBT 模块

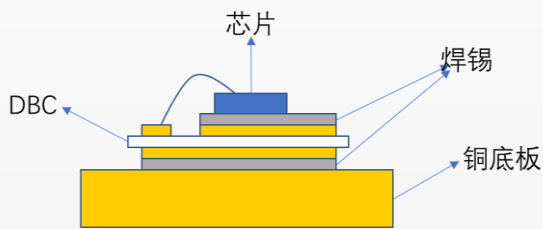

翠展集成散热水道的 IGBT 模块

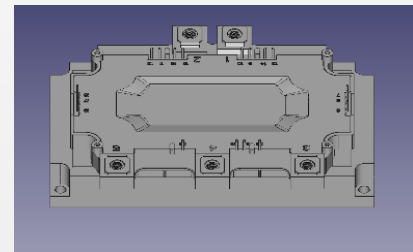
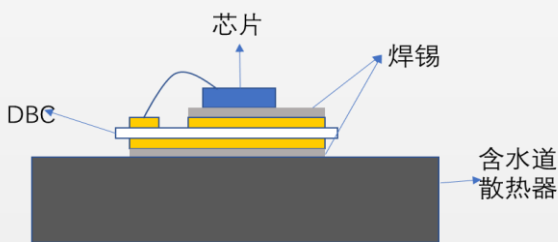

用常规 IGBT 模块的电机控制器

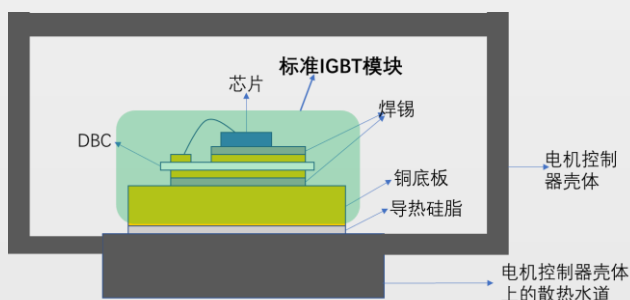

用翠展集成散热水道 IGBT 模块的电机控制器

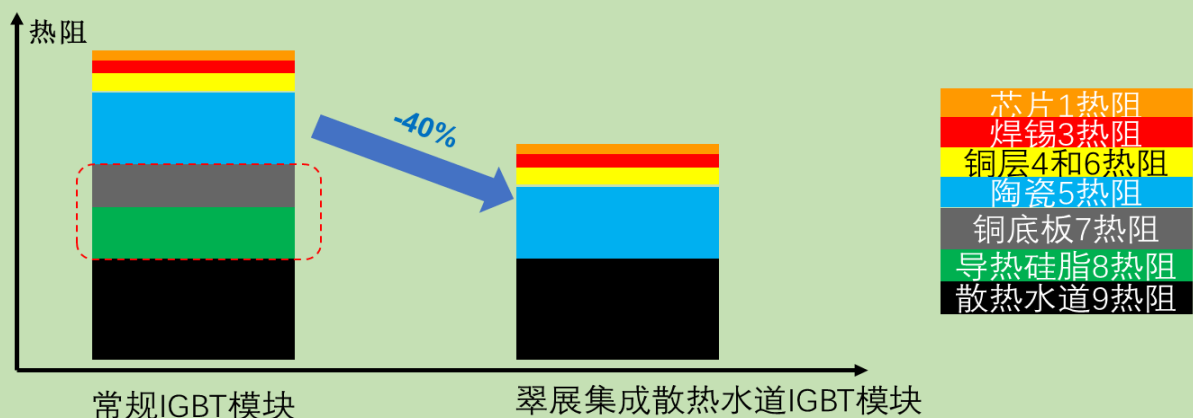
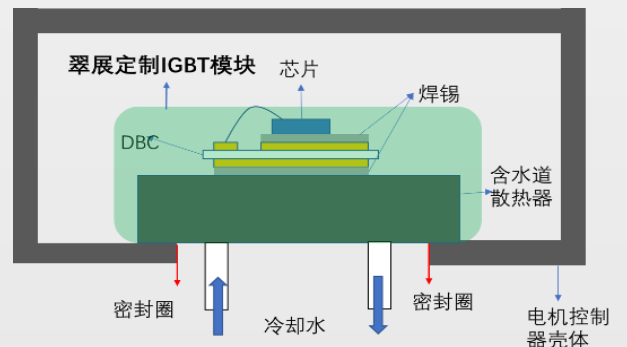

IGBT 单管产品

IGBT discrete

型号/ 功能描述	VCES	I _c	封装形式	应用	状态
GCV040NG120TH	1200V	40A	TO247	PTC 加热	量产
GCV075NG120TM	1200V	75A	TO247	PTC 加热	量产
GCV020NG40RI	400V	20A	TO252	点火用 IGBT, 250mJ	样品
GCV030NG40RI	400V	30A	TO252	点火用 IGBT, 300mJ	样品

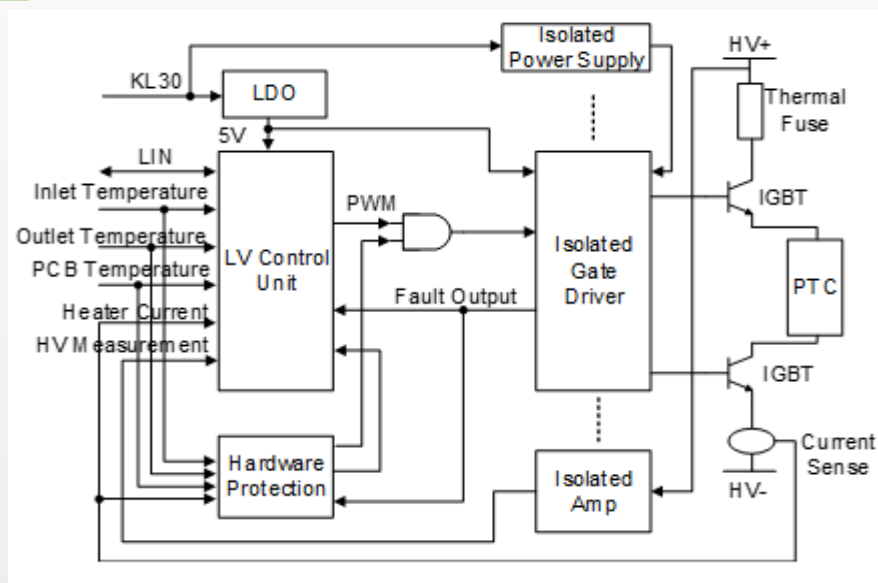

PTC 典型应用电路

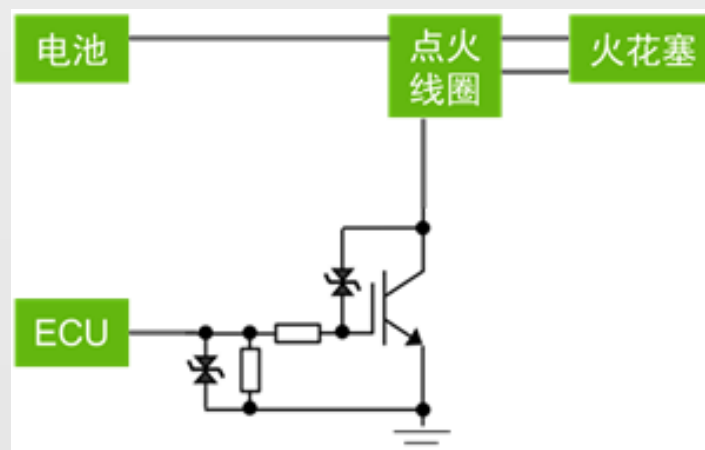

点火 IGBT 典型应用

联系我们

Contact us

<http://grecon-semi.com/>

上海

上海市浦东新区祖冲之路 2305 号 B
幢 515 室

电话: 021-58990598

苏州

江苏省苏州市工业园区金鸡湖大道
1355 号国际科技园二期 A203-5



嘉善

浙江省嘉兴市嘉善县滨江路 6 号 2
幢

电话: 0573-84982518

